

Type 66H Polycrete® Pit – polymer concrete pit and grate

Stainless 5 Star grate

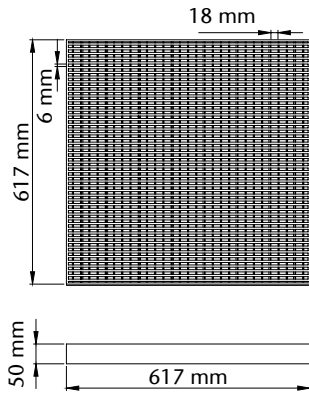

Galvanised Heelguard grate

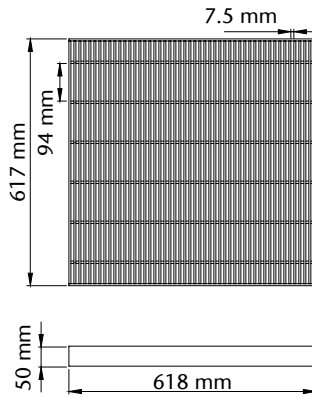

Galvanised Transverse grate

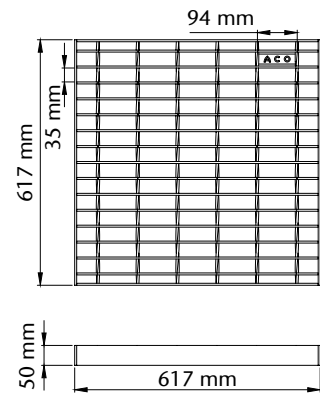

Drainage pit

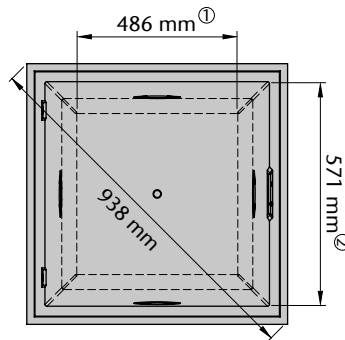

Key

- ① Clear working dimension at pit base.
- ② Clear working dimension at pit opening.
- ③ Pit invert depth.

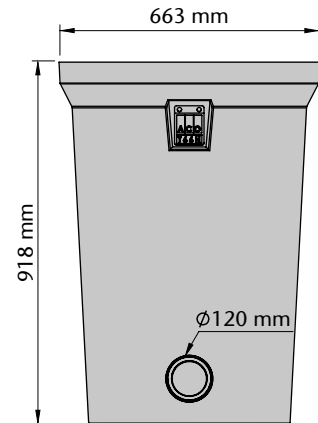
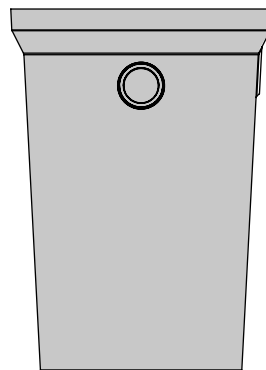
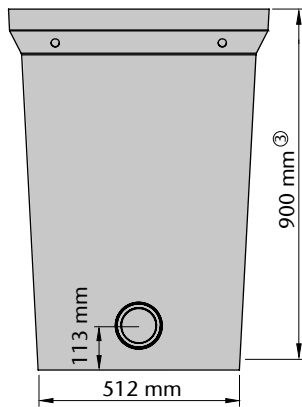

Optional riser

- each riser adds up to 300mm height

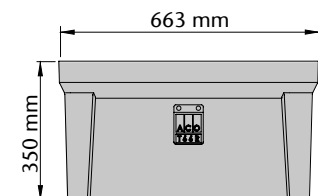
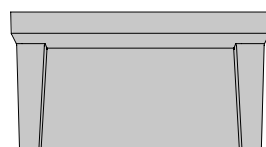
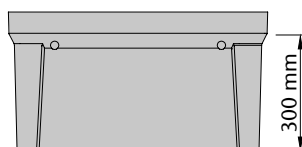
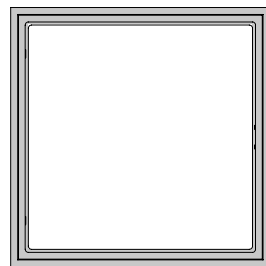

ACO Specification Information

ACO DRAIN®

Type 66H Polycrete® Pit – polymer concrete pit and grate

Pit/riser and grates				
Descriptions	Part No.	Slot Size (mm)	Intake Area (mm ²)	Weight (kg)
Type 66H Polymer concrete pit	77010	-	-	116
Type 66 Polymer concrete riser	77062	-	-	37
Type 66 Stainless 5 Star Heelsafe ® Anti-Slip grate (330kg nominal wheel load)	141810	18 x 6	175,680	13.7
Type 66 Stainless 5 Star Heelsafe ® Anti-Slip grate - locking (330kg nominal wheel load)	142075	18 x 6	175,680	13.7
Type 66 Galvanised Heelguard grate (2,670kg nominal wheel load)	90054	94 x 7.5	209,510	48.0
Type 66 Galvanised Heelguard grate - locking (2,670kg nominal wheel load)	78680	94 x 7.5	209,510	48.0
Type 66 Galvanised Transverse grate (2,670kg nominal wheel load)	78710	94 x 35	307,090	16.1
Type 66 Galvanised Transverse grate - locking (2,670kg nominal wheel load)	78724	94 x 35	307,090	16.1
Type 66 Galvanised Transverse grate (5,000kg nominal wheel load)	77645	94 x 35	307,090	24.3
Type 66 Galvanised Transverse grate - locking (5,000kg nominal wheel load)	77657	94 x 35	307,090	24.3

Notes:

1. Locking grate includes bar and brackets.
2. Stainless steel grade 304.

Specifications

The grated pit shall be ACO Drain® - Type 66H Polycrete® Pit – polymer concrete pit and grate as manufactured by ACO.

Type 66H pit and risers* shall be manufactured from polyester resin polymer concrete and installed in accordance with the manufacturer's installation instructions.

Type 66H pits have a clear opening of 571mm x 571mm with an invert depth of 900mm. The overall dimensions of the Type 66H pit is 663mm x 663mm x 918mm deep. Type 66 risers add 300mm to the overall depth of the pit.*

Grate for the Type 66H pit shall be standard non-locking / locking* and grate type:

- Stainless 5 Star **Heelsafe**® Anti-Slip grate (330kg nominal wheel load).*
- Galvanised Heelguard grate (2,670kg nominal wheel load).*
- Galvanised Transverse grate (2,670kg nominal wheel load).*
- Galvanised Transverse grate (5,000kg nominal wheel load).*

* delete as applicable

ACO Limited

New Zealand

Ph: 0800 448 080

www.aconz.co.nz

sales@aconz.co.nz

© March 2022 ACO Limited. All reasonable care has been taken in compiling the information in this document. All recommendations and suggestions on the use of ACO products are made without guarantee since the conditions of use are beyond the control of the company. It is the customer's responsibility to ensure that each product is fit for its intended purpose and that the actual conditions are suitable. ACO Limited pursues a policy of continuous product development and reserves the right to amend specifications without notice.

